

Typical Features

- ◆ Fixed input voltage, isolated & regulated, output power 1.0W
- ◆ Efficiency up to 73% (Typ.)
- ◆ Mini SMD package, international standard pin-out
- ◆ Isolation Voltage 1500VDC
- ◆ Operating Temperature from -40°C to +85°C
- ◆ Plastic case, flame class UL94 V-0



Test conditions: Unless otherwise specified, all parameter values had been tested at nominal input voltage, pure resistive rated load, and at room temperature 25 °C.

Application Filed

This series of converters can be widely used in the fields of instrument, communication, pure digital circuit, general low frequency analog circuit, relay drive circuit, data exchange circuit, etc.

Typical Product List

Certificate	Part No.	Input Voltage Range (VDC)		Output Voltage/Current		Input Current (mA)Typ. @Nominal Voltage		Max. Capacitive Load	Ripple & Noise 20MHz (mVp-p)	Efficiency (%) @full load/Nom. input	
		Nom.	Range	Vo (VDC)	Io (mA) Max / Min	Full load	No Load	uF (Max)	Max/Typ	Min	Typ
-	NW1-3V3S3V3ANT	3.3	3.135	3.3	250/20	290	8	2400	80/50	67	70
-	NW1-3V3S05ANT		-	3.465	5	200/20	288	8	2400	80/50	69
-	NW1-05S3V3ANT	5	4.75	3.3	250/25	290	6	2400	80/50	67	70
-	NW1-05S05ANT		-	5	200/20	265	6	2400	80/50	70	73
-	NW1-05S12ANT		5.25	12	84/9	260	8	560	80/50	70	73
-	NW1-12S3V3ANT	12	11.4	3.3	250/25	110	8	2400	80/50	67	70
-	NW1-12S05ANT		-	5	200/20	108	8	2400	80/50	70	73
-	NW1-12S12ANT		12.6	12	84/9	107	8	560	80/50	70	73
-	NW1-24S3V3ANT	24	22.8	3.3	250/25	56	8	2400	80/50	67	70
-	NW1-24S05ANT		-	5	200/20	54	8	2400	80/50	70	73
-	NW1-24S12ANT		25.2	12	84/9	52	8	560	80/50	70	73

Note - The ripple and noise are tested by the twisted pair method.

Input Specifications

Item	Operating Condition	Min.	Typ.	Max.	Unit
Input inrush voltage (1Second Max.)	3.3Vdc Input	-0.7	--	7	Vdc
	5Vdc Input	-0.7	--	9	
	9Vdc Input	-0.7	--	12	
	12Vdc Input	-0.7	--	18	

	15Vdc Input	-0.7	--	21	
	24Vdc Input	-0.7	--	30	
Input Filter Type	Capacitor Filter				
Hot Plug	Unavailable				

Output Specifications

Item	Operating Condition	Min.	Typ.	Max.	Unit
Output Power		0.1	--	1.0	W
Output Voltage Accuracy	Nominal input voltage, full load	--	±2	±3	%
Load Regulation	10%-100% load	--	--	±3	
Line Regulation	Input voltage change ±1%	--	--	±0.25	
Temperature Drift Coefficient	Full load	--	--	±0.03	%/°C
Short Circuit Protection	Continuous, Self-recovery				

General Specifications

Item	Operating Condition	Min.	Typ.	Max.	Unit
Switching Frequency	Nominal input voltage, full load	--	260	--	KHz
Operating Temperature	Refer to the temperature derating curve	-40	--	+85	°C
Storage Temperature		-55	--	+125	
Case Temperature Rise	Operating at Ta =25°C	--	30°	--	
Pin Soldering Temperature	1.5mm from the case, 10S	--	--	300	
Reflow Temperature	Peak temperature Tc ≤250°C, the maximum time above 217°C is 60S				
Relative Humidity	No condensing	5	--	95	%RH
Isolation Voltage	Input-Output, test 1min, leakage current <1mA	1500	--	--	VDC
Insulation Resistance	Input-Output, @ 500Vdc	1000	--	--	MΩ
Isolation Capacitor	Input/Output, 100KHz/0.1V	--	20	--	pF
MTBF	MIL-HDBK-217F@25°C	3500	--	--	K hours
Vibration		10-150Hz, 10G, 30Min, along X, Y, Z			
Case Material	Plastic in Black, flame class UL94 V-0				
Product Weight	1.4 g (Typ.)				
Cooling Method	Natural air				

EMC Performance

EMI	CE	CISPR32/EN55032 CLASS B (with Recommended EMC Circuit)			
	RE	CISPR32/EN55032 CLASS B (with Recommended EMC Circuit)			
EMS	ESD	IEC/EN61000-4-2 Air ±8kV, Contact ±4kV perf. Criteria B			

Mechanical Dimensions

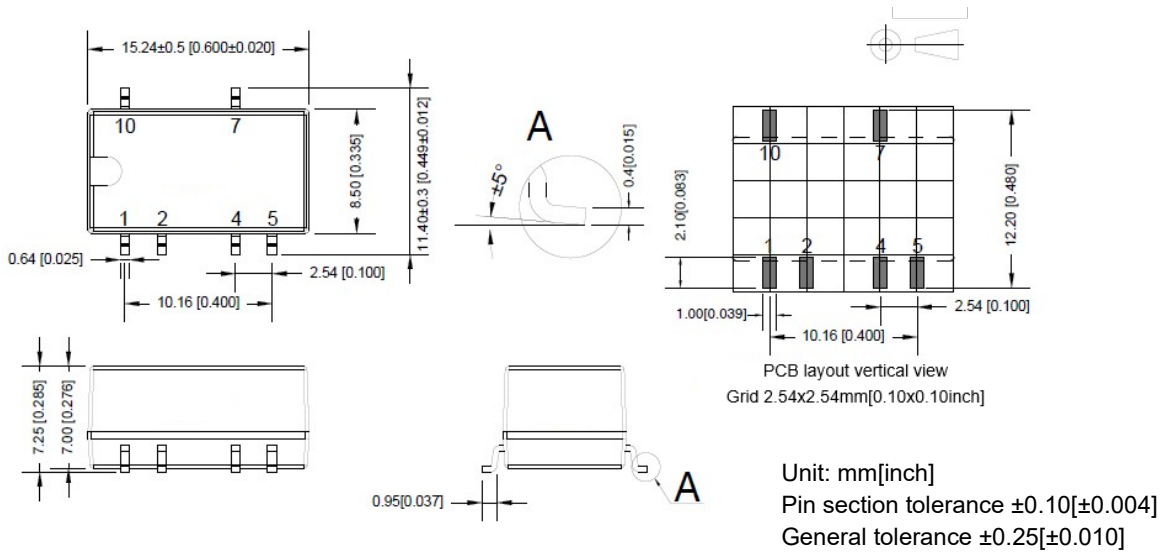

Packaging Code	Dimensions L x W x H	
ANT	15.24x11.40x7.25 mm	0.600x0.449x0.285 inch

Pin-out Definition

Pin No.	1	2	4	5	7	10
Pin definition	GND	+Vin	-Vo	-Vo	+Vo	NC
Description	Input GND	Input V+	Output V-	Output V-	Output V+	No connection

Note - Please take the pin definition on the product label marking as the right one if it is different than the one defined in this data sheet.
Pin #10 NC should not be connected to any circuit.

Ripple & Noise Test Instructions (Twisted Pair Method, 20MHz Bandwidth)

- The Ripple & noise test need 12# twisted pair cables, an oscilloscope which bandwidth should be set to 20MHz, 0.1uF polypropylene capacitor and 10uF high-frequency low-resistance electrolytic capacitor are connected in parallel with the probes (100M bandwidth). The oscilloscope should be set at the Sample Mode.
- The test diagram is shown on the right. The converter output connects to the electronic load by the jig with cables which size should be defined according to the output current value. The twisted pair (length 30cm \pm 2 cm) should be connected in parallel with the load, the location is as close as possible to the output pins or terminals. The test can be started after input power on.

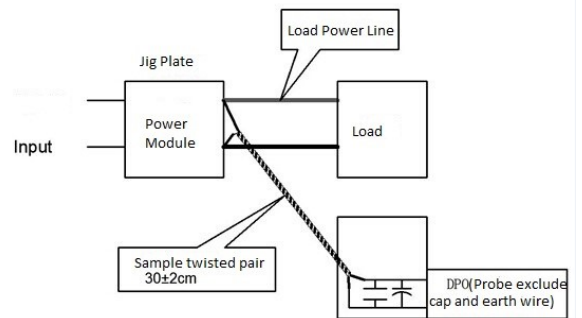

Product Performance Curve

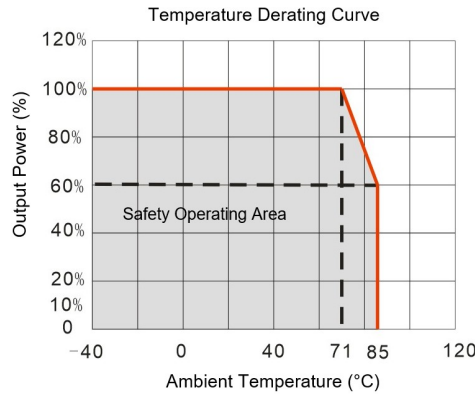

Recommended Circuits for Application

① **Output load requirement**

The maximum capacitive load of the product was tested at the Rated full load. The converter may not start or be damaged if the output capacitor exceeds this value.

② **Recommended circuits for application**

To effectively decrease the input and output ripple and noise, a capacitor filter should be connected at the input and output, the application circuit is shown in the figure below. The suitable filter capacitors should be chosen as the recommended capacitive load values in Table 1. The converter could not start if the capacitance is too big.

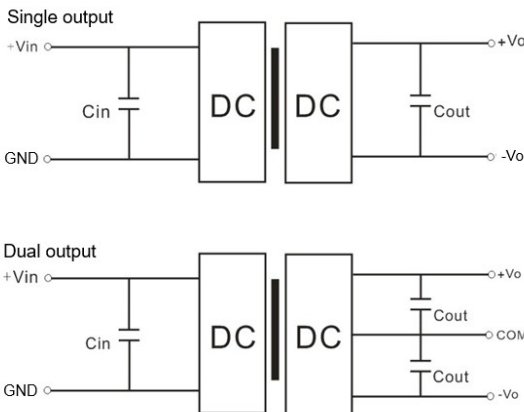

Recommended Capacitive Load Value Table (Table 1)

Vin (Vdc)	Cin	Single Vout (Vdc)	Cout (μF)	Dual Vout (Vdc)	Cout (μF)
5	10 μF/16V	3.3	10 μF/16V	±3.3	4.7 μF/16V
12	2.2 μF/25V	5	10 μF/16V	±5	4.7 μF/16V
15	2.2 μF/25V	9	2.2 μF/25V	±9	2.2 μF/25V
24	1 μF/50V	12	2.2 μF/25V	±12	1 μF/25V
--	--	15	1 μF/25V	±15	1 μF/16V
--	--	24	1 μF/50V	±24	0.47 μF/50V

③ **Recommended EMC Circuit**

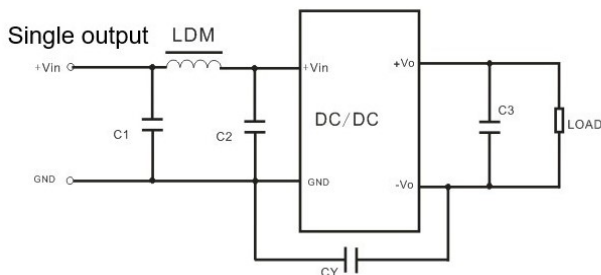

Input voltage		5VDC	12/15/24VDC
EMI	C1/C2	4.7μF/16V	4.7μF/50V
	CY	270pF/2KV	270pF/2KV
	C3	Refer to Cout in Table 1	
	LDM	6.8 μH	6.8 μH

Packing information

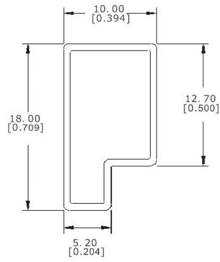

Note:
Unit: mm[inch]
General tolerance: ±1.50[±0.059]
Packing QTY: 33pcs/Tube
Packing QTY: 2640pcs/Carton
Tube size: 525x18x10mm
Carton size: 542x110x155mm

Tube packing

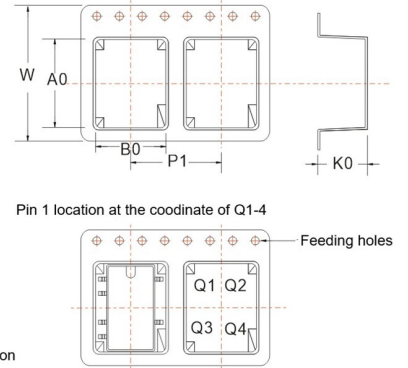
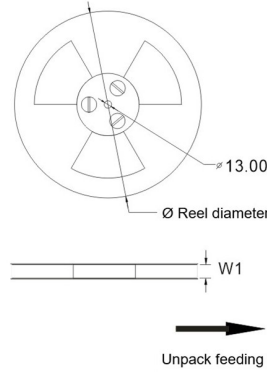
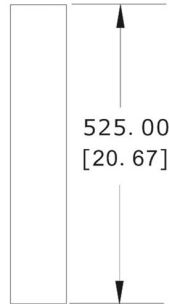

Part No.	Packaging Type	Pin	SPQ	Reel Diameter (mm)	Reel Width W1 (mm)	A0 (mm)	B0 (mm)	K0 (mm)	P1 (mm)	W1 (mm)	Pin1 Location
NWX-XXSXXA(3)NT	SMD	6	500	330.0	24.5	15.65	12.05	8.0	16.0	24.0	Q1

Reel packing (500pcs per Reel)

Application Notice

- 1.This product cannot be used in parallel, and it does not support hot-plugging.
- 2.The product performance in this manual cannot be guaranteed if it works at a lower load than the minimum load condition.
3. All values or indicators in this manual had been tested based on Aipupower test specifications.

Guangzhou Aipu Electron Technology Co., Ltd

Address: Building 4, HEDY Park, No.63, Punan Road, Huangpu Dist, Guangzhou, China.

Tel: 86-20-84206763 Fax: 86-20-84206762 HOTLINE: 400-889-8821

E-mail: sales@aipu-elec.com Website: <https://www.aipupower.com>